

DATASHEET 规格书

SISD0600ED170i20

ED-Type phase leg IGBT module

ED 封装半桥 IGBT 模块



$V_{CE} = 1700\text{ V}$

$I_C = 2 \times 600\text{ A}$

- *i20* ultra-low loss fine pattern Trench IGBT chipset
i20 超低损耗精细沟槽栅型 IGBT 芯片组
- Baseplate isolation with efficient Al_2O_3 ceramic
高效 Al_2O_3 绝缘陶瓷基板
- Cu baseplate for low thermal resistance
低热阻铜底板
- Industry standard package
行业标准封装

Maximum ratings¹ 最大额定值¹

PARAMETER 参数	SYMBOL 符号	CONDITIONS 工作条件	MIN 最小值	MAX 最大值	UNIT 单位
Collector-emitter voltage 集电极-发射极电压	V_{CES}	$V_{GE} = 0\text{ V}$, $T_{vj} = 25\text{ °C}$		1700	V
DC collector current 集电极直流电流	I_C	$T_C = 115\text{ °C}$, $T_{vj} = 175\text{ °C}$		600	A
Peak collector current 集电极峰值电流	I_{CM}	$t_p = 1\text{ ms}$		1200	A
Gate-emitter voltage 栅极-发射极驱动电压	V_{GES}		-20	20	V
Total power dissipation 最大功率损耗	P_{tot}	$T_C = 25\text{ °C}$, $T_{vj} = 175\text{ °C}$, per switch		3570	W
DC forward current 二极管直流正向电流	I_F			600	A
Peak forward current 二极管最大脉冲正向电流	I_{FRM}	$t_p = 1\text{ ms}$		1200	A
Surge current 二极管最大浪涌电流	I_{FSM} I^2t	$V_R = 0\text{ V}$, $T_{vj} = 150\text{ °C}$, $t_p = 10\text{ ms}$, half-sinewave		2750 37500	A A ² s
Isolation voltage 绝缘电压	V_{isol}	1 min, $f = 50\text{ Hz}$		3400	V
Junction operating temperature 运行结温	$T_{vj(OP)}$		-40	175 ²	°C
Case temperature 壳温	T_C		-40	125 ³	°C
Storage temperature 存储温度	T_{stg}		-40	125	°C
Mounting torques 紧固力矩 ⁴	M_S	Base-heatsink, M5 screws	3	6	Nm
	M_{t1}	Main terminals, M6 screws	3	6	Nm



Scan for latest version download 扫描最新下载

¹ Maximum rated values indicate limits beyond which damage to the device may occur per IEC 60747; 根据标准 IEC 60747 要求, 最大额定值表示超过该限值可能会对器件造成损坏

² $T_{vj(OP)} > 150\text{ °C}$ allowed for overload conditions, in maximum for 60s and less than 20% of operation time

³ For UL1557 compliance T_{Cmax} must be limited to 125°C

⁴ For details, please refer to the mounting instructions. 详细信息, 请参考安装说明书

IGBT⁵

PARAMETER 参数	SYMBOL 符号	CONDITIONS 工作条件	MIN 最小值	TYP 典型	MAX 最大值	UNIT 单位
Collector(-emitter) breakdown voltage 集电极-发射极击穿电压	$V_{(BR)CES}$	$V_{GE} = 0\text{ V}, I_C = 1\text{ mA}, T_{vj} = 25^\circ\text{C}$	1700			V
Collector-emitter saturation voltage⁶ 集电极-发射极饱和电压	V_{CESat}	$I_C = 600\text{ A}, V_{GE} = 15\text{ V}$	$T_{vj} = 25^\circ\text{C}$	1.65	2.0	V_{CESat}
			$T_{vj} = 125^\circ\text{C}$	1.85		V
			$T_{vj} = 175^\circ\text{C}$	2.05		V
Collector cut-off current 集电极截止电流	I_{CES}	$V_{CE} = 1700\text{ V}, V_{GE} = 0\text{ V}$	$T_{vj} = 25^\circ\text{C}$		1	I_{CES}
			$T_{vj} = 125^\circ\text{C}$		0.8	mA
			$T_{vj} = 175^\circ\text{C}$		13	mA
Gate leakage current 栅极漏电流	I_{GES}	$V_{CE} = 0\text{ V}, V_{GE} = \pm 20\text{ V}$	-0.5		0.5	μA
Gate-emitter threshold voltage 栅极-发射极阈值电压	$V_{GE(th)}$	$I_C = 30\text{ mA}, V_{CE} = V_{GE}, T_{vj} = 25^\circ\text{C}$	5	6.15	7.5	V
Gate charge 栅极电荷	Q_G	$I_C = 600\text{ A}, V_{CE} = 900\text{ V}, V_{GE} = -15\text{ V} \dots 15\text{ V}$		4.5		μC
Input capacitance 输入电容	C_{ies}	$V_{CE} = 25\text{ V}, V_{GE} = 0\text{ V}, f = 100\text{ kHz}, T_{vj} = 25^\circ\text{C}$		45.9		nF
Output capacitance 输出电容	C_{oes}			2.66		nF
Reverse transfer capacitance 反向传输电容	C_{res}			1.40		nF
Internal gate resistor 栅极内阻	R_{Gint}	Per switch, $f = 1\text{ MHz}, V_{GE} = 0\text{V}, CE$ short		1.4		Ω
Turn-on delay time 开通延迟	$t_{d(on)}$	$V_{CC} = 900\text{ V}, I_C = 600\text{ A}, R_G = 1.5\ \Omega, V_{GE} = \pm 15\text{ V}, L_S = 35\text{ nH},$ inductive load	$T_{vj} = 25^\circ\text{C}$	105		$t_{d(on)}$
			$T_{vj} = 125^\circ\text{C}$	130		ns
			$T_{vj} = 175^\circ\text{C}$	150		ns
Rise time 上升时间	t_r		$T_{vj} = 25^\circ\text{C}$	52		t_r
			$T_{vj} = 125^\circ\text{C}$	58		ns
			$T_{vj} = 175^\circ\text{C}$	62		ns
Turn-off delay time 关断延迟	$t_{d(off)}$	$V_{CC} = 900\text{ V}, I_C = 600\text{ A}, R_G = 1.5\ \Omega, V_{GE} = \pm 15\text{ V}, L_S = 35\text{ nH},$ inductive load	$T_{vj} = 25^\circ\text{C}$	590		$t_{d(off)}$
			$T_{vj} = 125^\circ\text{C}$	720		ns
			$T_{vj} = 175^\circ\text{C}$	775		ns
Fall time 下降时间	t_f		$T_{vj} = 25^\circ\text{C}$	360		t_f
			$T_{vj} = 125^\circ\text{C}$	570		ns
			$T_{vj} = 175^\circ\text{C}$	660		ns
Turn-on switching energy 开通损耗	E_{on}	$V_{CC} = 900\text{ V}, I_C = 600\text{ A}, R_G = 1.5\ \Omega, V_{GE} = \pm 15\text{ V}, L_S = 35\text{ nH},$ inductive load	$T_{vj} = 25^\circ\text{C}$	164		E_{on}
			$T_{vj} = 125^\circ\text{C}$	223		mJ
			$T_{vj} = 175^\circ\text{C}$	261		mJ
Turn-off switching energy 关断损耗	E_{off}	$V_{CC} = 900\text{ V}, I_C = 600\text{ A}, R_G = 1.5\ \Omega, V_{GE} = \pm 15\text{ V}, L_S = 35\text{ nH},$ inductive load	$T_{vj} = 25^\circ\text{C}$	133		E_{off}
			$T_{vj} = 125^\circ\text{C}$	192		mJ
			$T_{vj} = 175^\circ\text{C}$	216		mJ
Short circuit current 短路电流	I_{SC}	$t_{pCS} \leq 10\ \mu\text{s}, V_{GE} = 15\text{ V}, T_{vj} = 175^\circ\text{C}, V_{CC} = 1200\text{V}, V_{CEM\ Chip} \leq 1700\text{ V}$		2300		A

⁵ Characteristic values according to IEC 60747-9

⁶ Collector-emitter saturation voltage is given at chip-level 集电极-发射极饱和电压

Diode⁷

PARAMETER 参数	SYMBOL 符号	CONDITIONS 工作条件		MIN 最小值	TYP 典型	MAX 最大值	UNIT 单位
Forward voltage ⁸ 正向压降	V _F	I _F = 600 A	T _{vj} = 25 °C		1.7	2.15	V
			T _{vj} = 125 °C		1.85		V
			T _{vj} = 175 °C		1.95		V
Peak reverse recovery current 反向恢复电流峰值	I _{RM}	V _R = 900 V, I _F = 600 A, dI _F /dt = 10200 A/μs (175 °C), R _G = 1.5 Ω, V _{GE} = ± 15 V, L _S = 35 nH, inductive load	T _{vj} = 25 °C		635		A
			T _{vj} = 125 °C		627		A
			T _{vj} = 175 °C		612		A
Recovery charge 恢复电荷	Q _{rr}		T _{vj} = 25 °C		149		μC
			T _{vj} = 125 °C		224		μC
			T _{vj} = 175 °C		272		μC
Reverse recovery time 反向恢复时间	t _{rr}		T _{vj} = 25 °C		774		ns
			T _{vj} = 125 °C		1160		ns
			T _{vj} = 175 °C		1420		ns
Reverse recovery energy 反向恢复能量	E _{rec}		T _{vj} = 25 °C		75		mJ
			T _{vj} = 125 °C		124		mJ
			T _{vj} = 175 °C		153		mJ

NTC Thermistor

PARAMETER 参数	SYMBOL 符号	CONDITIONS 工作条件	MIN 最小值	TYP 典型	MAX 最大值	UNIT 单位
Rated resistance 额定电阻	R ₂₅	T _C = 25 °C		5		kΩ
R100	R ₁₀₀	T _C = 100 °C	468		518	Ω
B-value B 值	B _{25/50}	$R_2 = R_{25} \exp [B_{25/50}(1/T_2 - 1/(298.15K))]$		3375		K
B-value B 值	B _{25/100}	$R_2 = R_{25} \exp [B_{25/100}(1/T_2 - 1/(298.15K))]$		3433		K

⁷ Characteristic values according to IEC 60747-2

⁸ Forward voltage is given at chip-level 正向压降是芯片两端的电压值。

Package properties 封装特性⁹

PARAMETER 参数	SYMBOL 符号	CONDITIONS 工作条件	MIN 最小值	TYP 典型	MAX 最大值	UNIT 单位
IGBT thermal resistance junction to case IGBT 结-壳热阻	$R_{th(j-c)IGBT}$	Per switch 每一个开关			0.042	K/W
Diode thermal resistance junction to case 二极管结-壳热阻	$R_{th(j-c)Diode}$				0.073	K/W
IGBT thermal resistance case to heatsink IGBT 壳到散热器热阻	$R_{th(c-s)IGBT}$	IGBT per switch IGBT 每一个开关		0.030		K/W
Diode thermal resistance case to heatsink 二极管壳到散热器热阻	$R_{th(c-s)Diode}$	diode per switch 二极管每一个开关		0.036		K/W
Comparative tracking index 相对漏电起痕指数	CTI		200			
Module stray inductance 模块自身杂散电感	$L_{s CE}$	Per switch 每一个开关		20		nH
Resistance, terminal chip 端子到芯片之间的阻抗	R_{CC+EE}	Per switch 每一个开关	$T_{vj} = 25\text{ °C}$	0.9		mΩ
			$T_{vj} = 125\text{ °C}$	1.25		mΩ
			$T_{vj} = 175\text{ °C}$	1.4		mΩ
Maximum RMS DC-Terminal current 最大端子电流	$I_{Term RMS}$		$T_{Terminal} = 90\text{ °C}$	580		A
			$T_{Terminal} = 105\text{ °C}$	565		A

Mechanical properties 机械特性

PARAMETER 参数	SYMBOL 符号	CONDITIONS 工作条件	MIN 最小值	TYP 典型	MAX 最大值	UNIT 单位
Dimensions	L x W x H	Typical	152 x 62 x 17			mm ³
Clearance distance in air 电气间隙	d_a	According to IEC 60664-1 and EN 50124-1 参考标准 IEC 60664-1 和 EN 50124-1	Terminal to base: 端子到基板	12.5		mm
			Terminal to terminal: 端子到端子	10		mm
Surface creepage distance 爬电距离	d_s	According to IEC 60664-1 and EN 50124-1 参考标准 IEC 60664-1 和 EN 50124-1	Terminal to base: 端子到基板	14.5		mm
			Terminal to terminal: 端子到端子	13		mm
Mass 重量	m			350		g

⁹ Package and mechanical properties according to IEC 60747-15



Electrical configuration 电气图

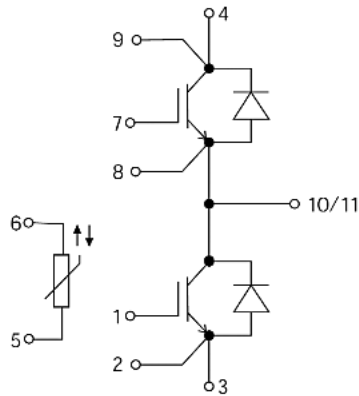

Outline drawing 外形图

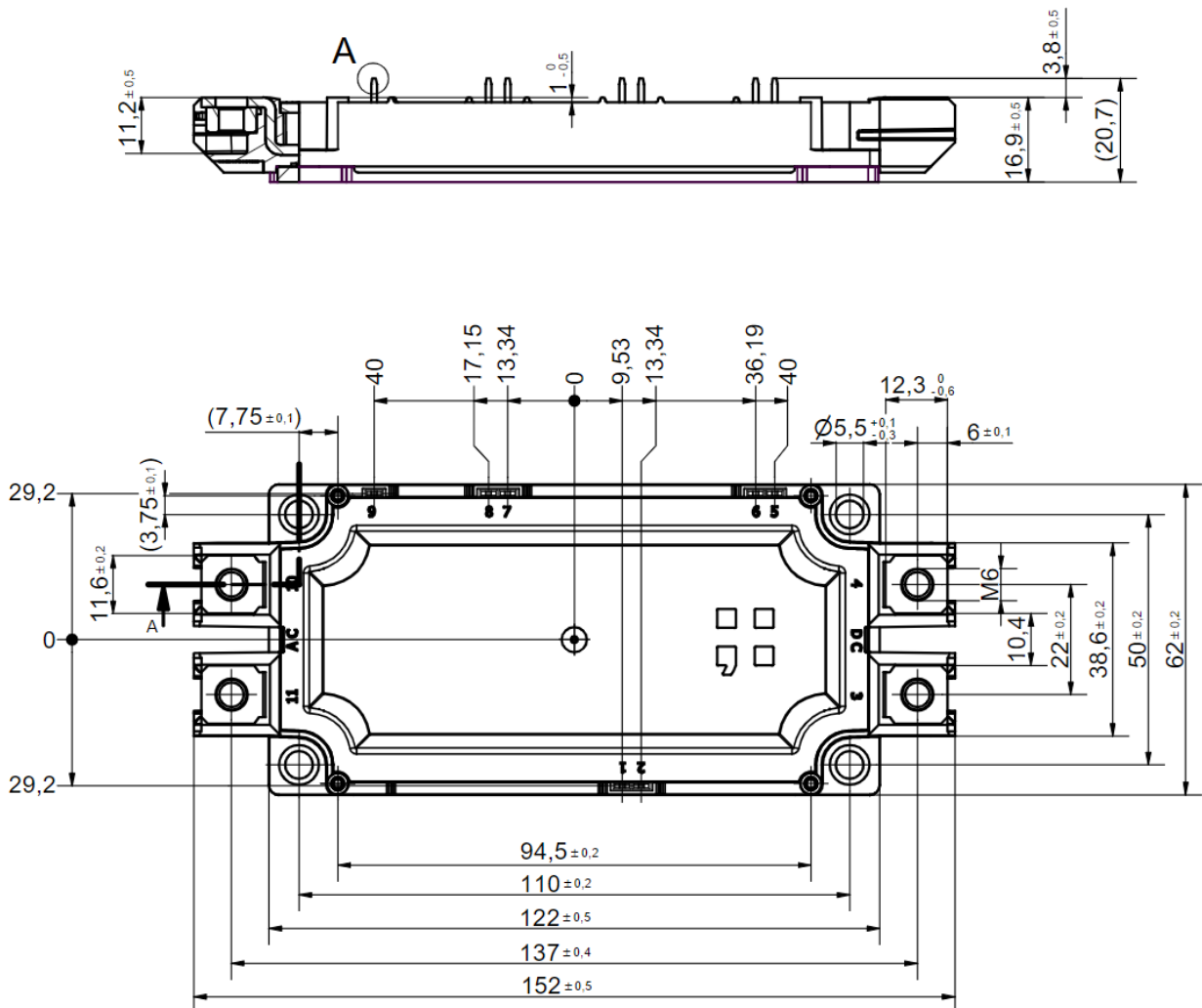

This is an electrostatic sensitive device. 本产品对静电特别敏感。
 This product has been designed and qualified for Industrial Level. 本产品的设计符合工业级标准。



Characteristics 特性曲线

IGBT on-state characteristics (typical)

IGBT 通态特性曲线 (典型)

$I_C = f(V_{CE})$
 $V_{GE} = 15\text{ V}$

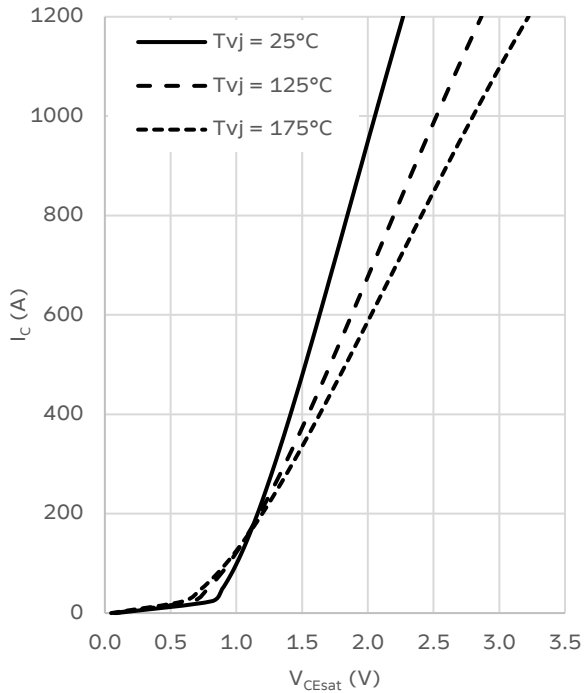

IGBT transfer characteristics (typical)

IGBT 转移特性曲线 (典型)

$I_C = f(V_{GE})$
 $V_{CE} = 20\text{ V}$

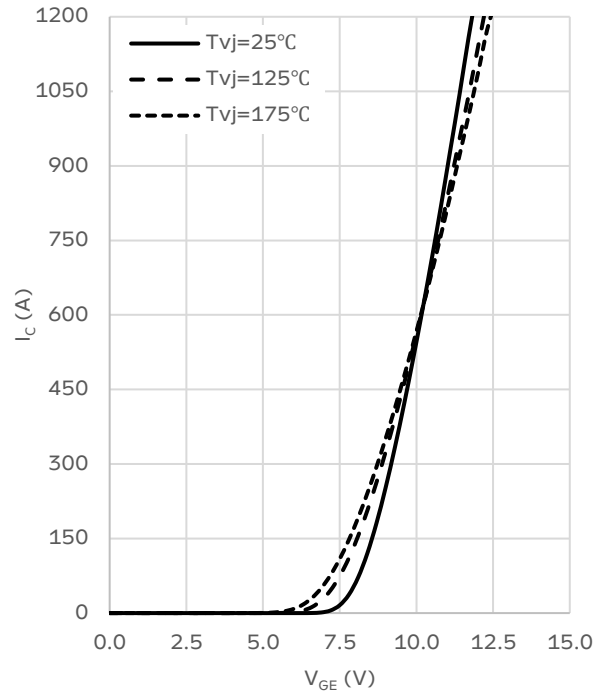

IGBT output characteristics (typical)

IGBT 输出特性曲线 (典型)

$I_C = f(V_{CE})$
 $T_{vj} = 25^\circ\text{C}$

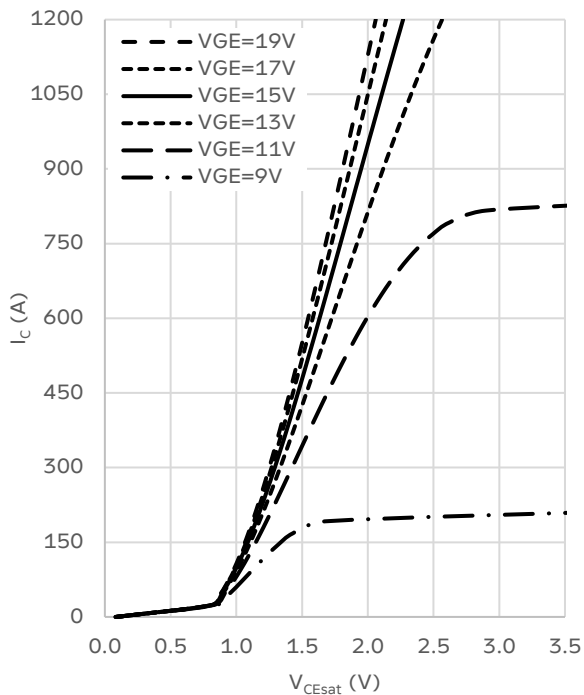

IGBT output characteristics (typical)

IGBT 输出特性曲线 (典型)

$I_C = f(V_{CE})$
 $T_{vj} = 175^\circ\text{C}$

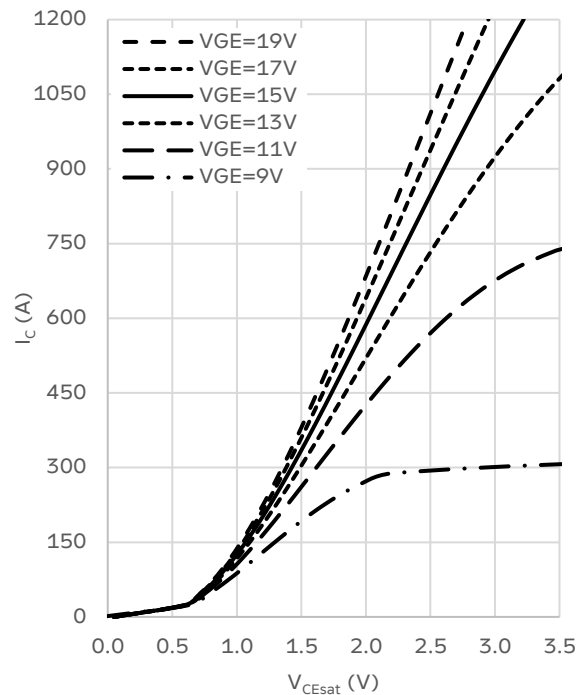



IGBT switching losses (typical)

IGBT 开关损耗曲线 (典型)

$E = f(I_{CE})$

$V_{CE} = 900 \text{ V}, R_{Gon} = 1.5 \text{ } \Omega, R_{Goff} = 1.5 \text{ } \Omega, V_{GE} = -15/+15 \text{ V}$

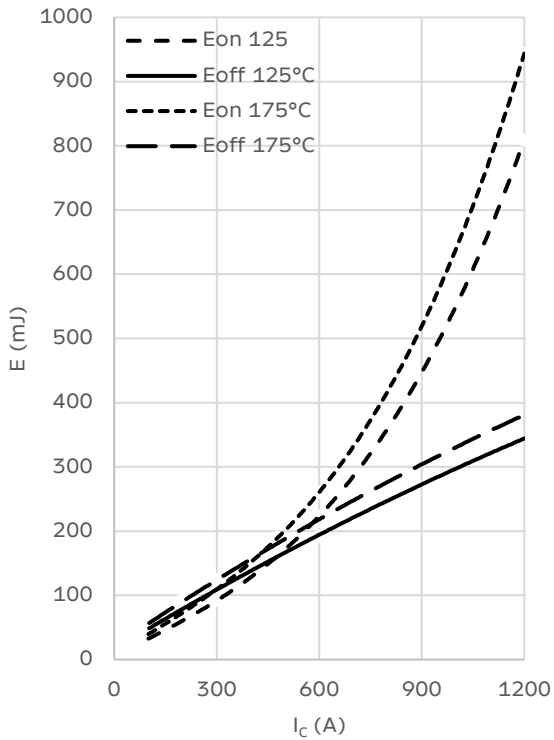

IGBT switching times (typical)

IGBT 开关时间曲线 (典型)

$t = f(I_{CE}), T_{vj} = 175 \text{ } ^\circ\text{C}$

$V_{CE} = 900 \text{ V}, R_{Gon} = 1.5 \text{ } \Omega, R_{Goff} = 1.5 \text{ } \Omega, V_{GE} = -15/+15 \text{ V}$

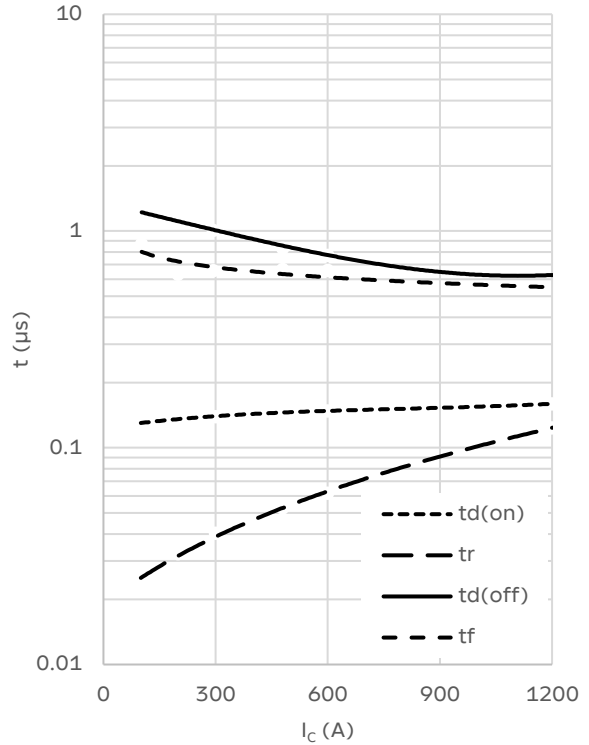

IGBT switching losses (typical)

IGBT 开关损耗曲线 (典型)

$E = f(R_G)$

$V_{CE} = 900 \text{ V}, I_C = 600 \text{ A}, V_{GE} = -15/+15 \text{ V}$

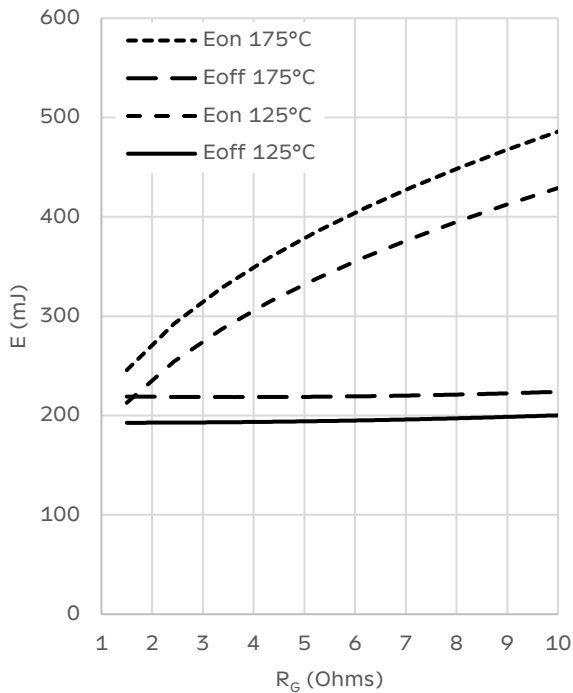

IGBT switching times (typical)

IGBT 开关时间曲线 (典型)

$t = f(R_G), T_{vj} = 175 \text{ } ^\circ\text{C}$

$V_{CE} = 900 \text{ V}, I_C = 600 \text{ A}, V_{GE} = -15/+15 \text{ V}$

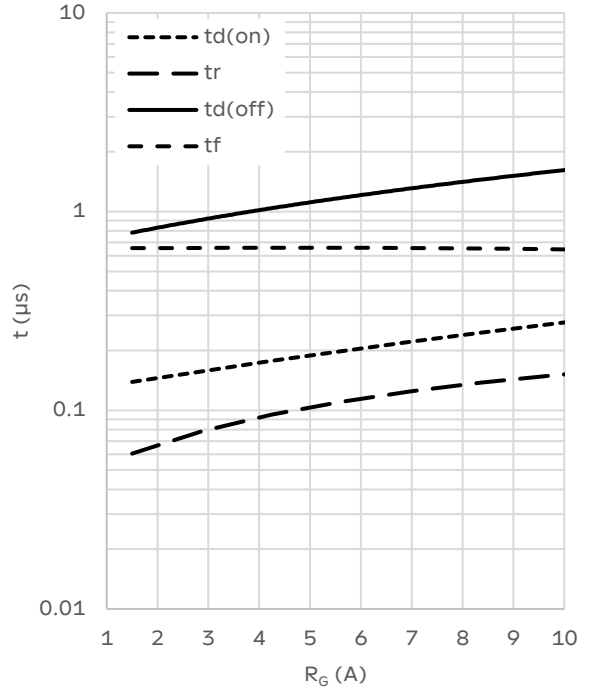



IGBT gate charge (typical)

IGBT 门极电荷 (典型)

$V_{GE} = f(Q_G), T_{vj} = 25\text{ }^\circ\text{C}$

$V_{CE} = 900\text{ V}, I_C = 600\text{ A}$

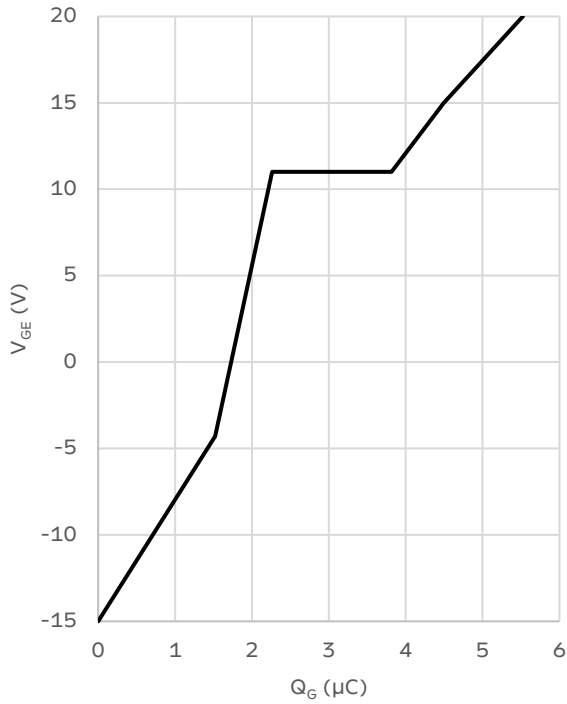

Capacitance characteristics (typical)

电容特性曲线 (典型)

$C = f(V_{CE}), T_{vj} = 25\text{ }^\circ\text{C}$

$f = 100\text{ kHz}, V_{GE} = 0\text{ V}$

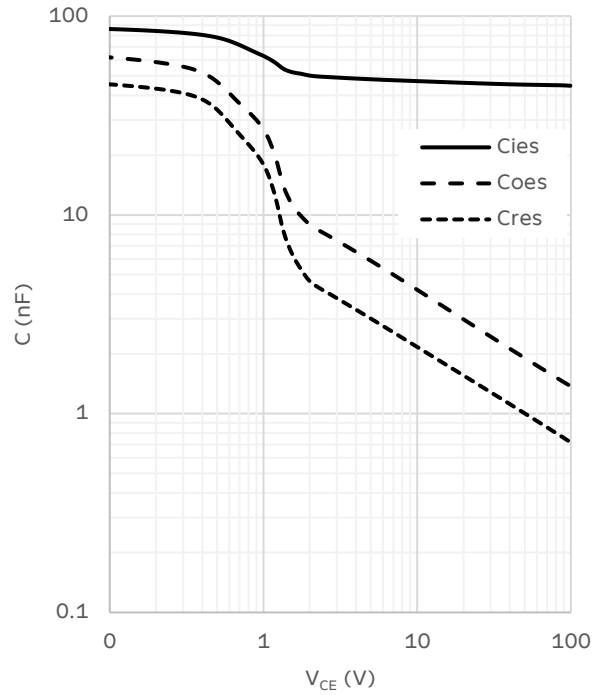

IGBT RBSOA

IGBT 反偏安全工作区域

$I_C = f(V_{CEm})$

$R_{Goff} = 1.5\ \Omega, V_{GE} = \pm 15\text{ V}$

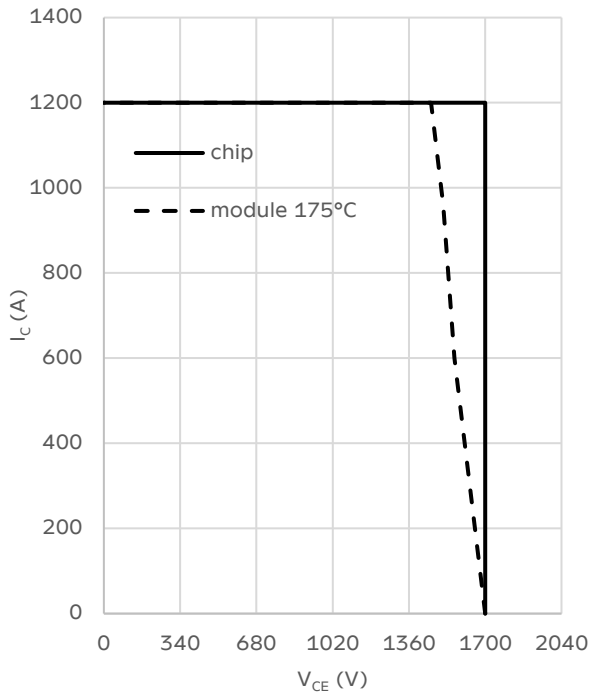

Diode SOA

Diode 反偏安全工作区域

$T_{vj} \leq 175\text{ }^\circ\text{C}$

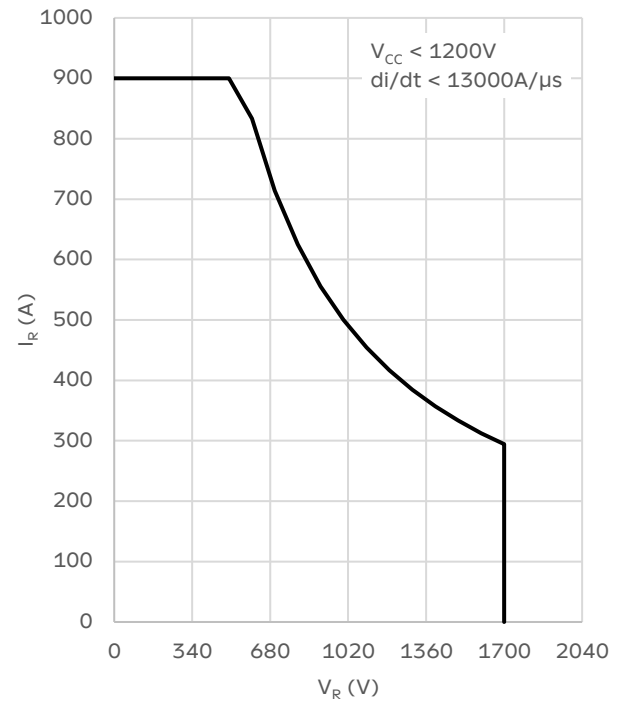



Diode forward characteristic (typical)

二极管正向特性 (典型)

$I_F = f(V_F)$

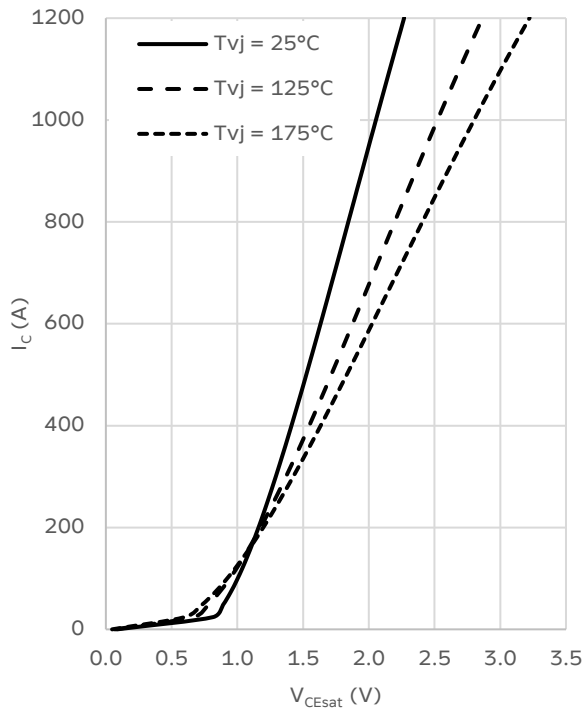

Diode switching characteristics (typical)

二极管开关特性 (典型)

$E_{rec} = f(I_F), I_{RM} = f(I_F)$

$V_{DC} = 900\text{ V}, R_{Gon} = 1.5\ \Omega$ (IGBT), $V_{GE} = -15/+15\text{ V}$ (IGBT)

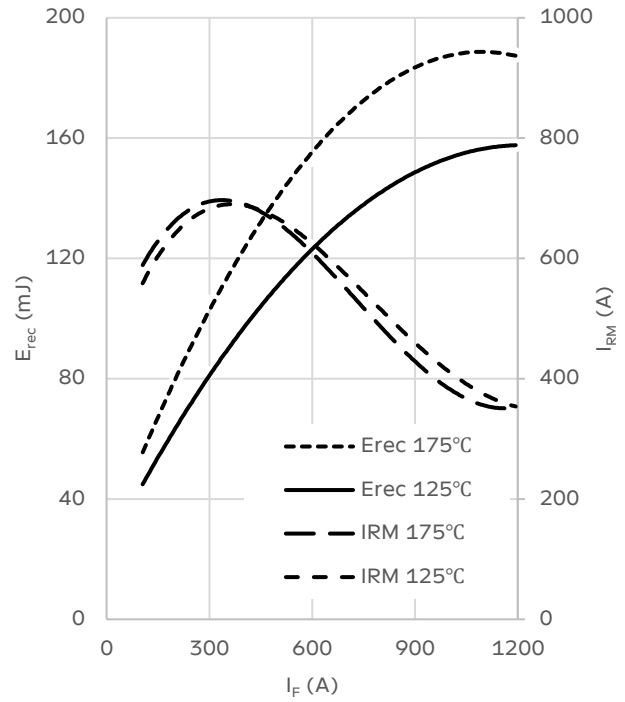

Diode switching characteristics (typical)

二极管开关特性 (典型)

$E_{rec} = f(di/dt), I_{RM} = f(di/dt)$

$V_{DC} = 900\text{ V}, I_F = 600\text{ A}, V_{GE} = -15/+15\text{ V}$ (IGBT)

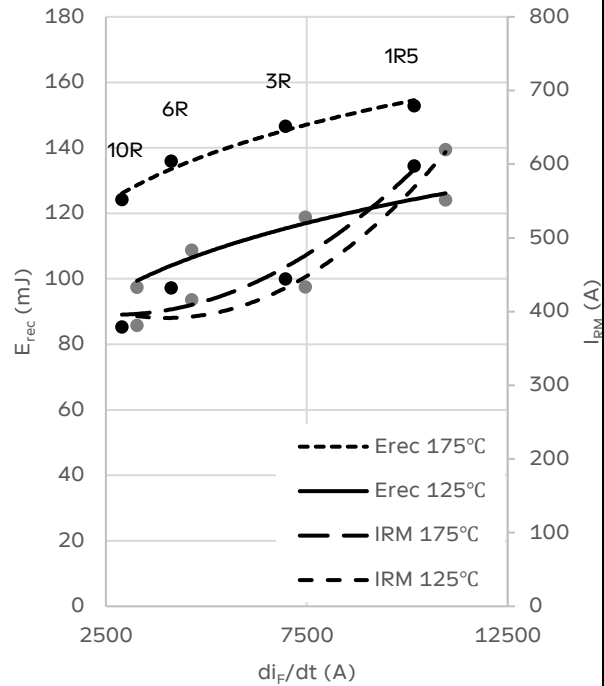

Thermal impedance (typical)

热阻抗 (典型)

$Z_{th(j-c)} = f(t)$

