

A-A

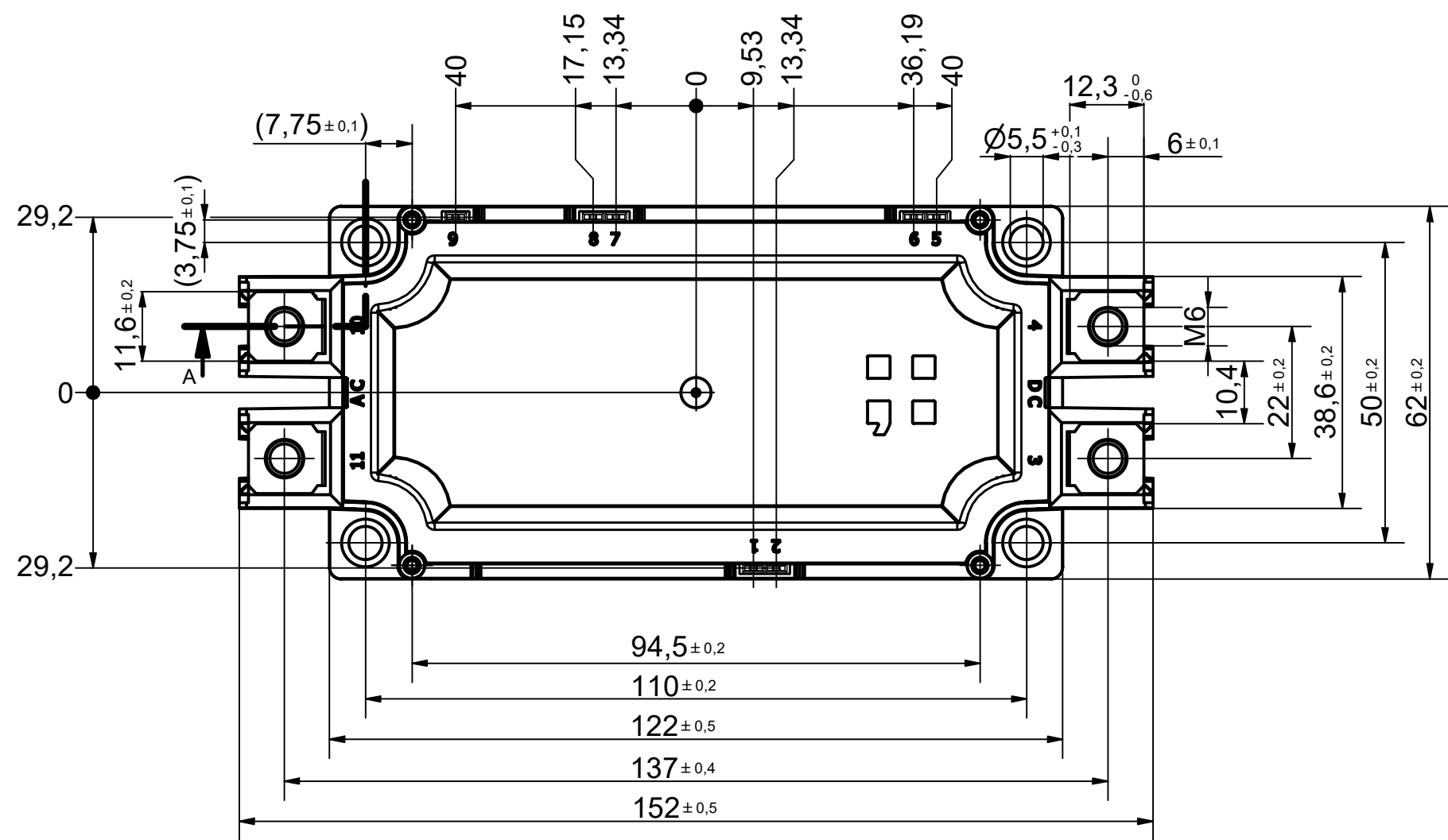

A (2:1)

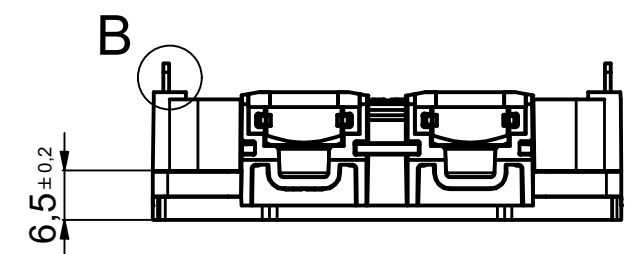
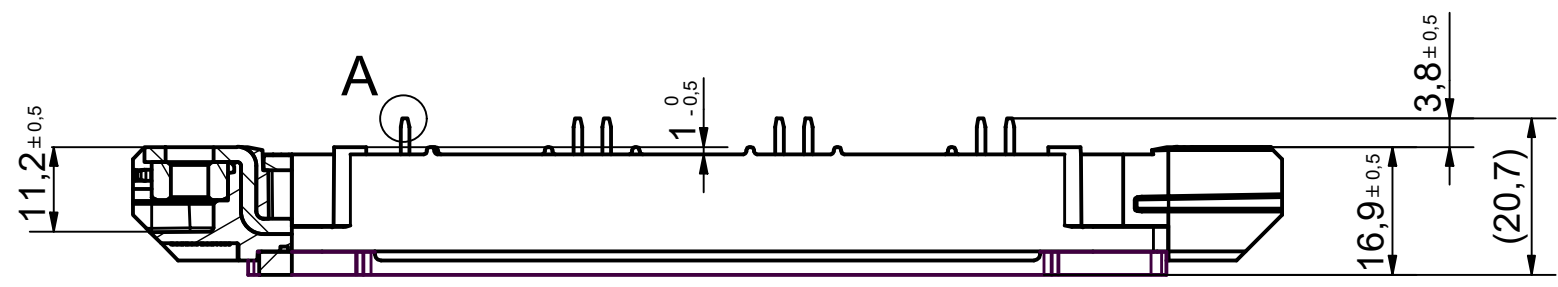
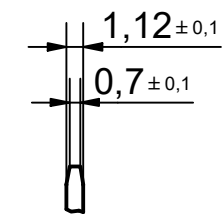

B (2:1)

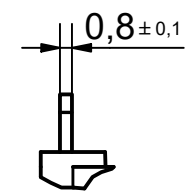

prepared: 23.06.2022	Chantal Toker	Scale: 1:1	Article number: SISD0xx0ED120i20
checked:		Sheet: 1/2	Description: Outline Drawing ED
approved: 24.06.2022	Sven Matthias	Format: A3	Document number: DRW 0009
		STD Tolerances ISO 2768-mk ISO 1302 ISO 13715	Revision: 03

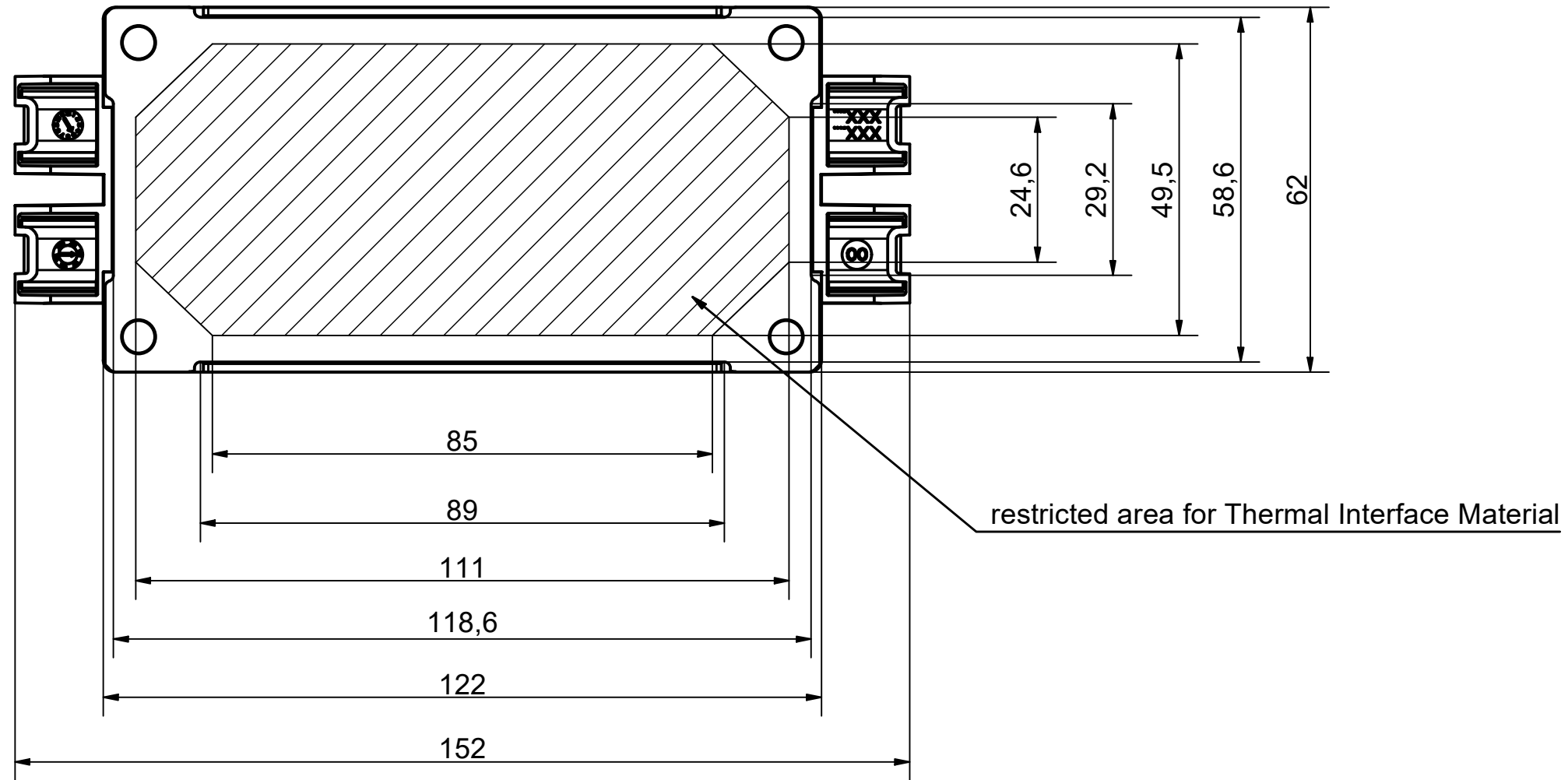

prepared: 23.06.2022	Chantal Toker	Scale: 1:1	Article number: SISD0xx0ED120i20
checked:		Sheet: 2 / 2	Description: Outline Drawing ED
approved: 24.06.2022	Sven Matthias	Format: A3	Document number: DRW 0009
SwissSEM  Technologies AG		STD Tolerances ISO 2768-mk ISO 1302 ISO 13715	Revision: 03